

DA26 0,1 µm/m bis 1300 µm/m



Description

The DA26 extension sensor is suitable for high-resolution detection of forces and deformations on massive components e.g. presses, hoists, containers, steel girders, bridges, connecting rods or frames of manufacturing machinery.

Subsequent installation makes these extensions sensors universal, retrofit sensors for force and load monitoring. These extension sensors are durable and resistant against oil and moisture.

The most efficient assembly is across the load direction. No force can be transferred thanks to the housing. However, assembly along the direction of compression is possible for strains of up to 100µm/m without limiting accuracy. The DA26 sensor is also available without countersink for assembly with superimposed threaded bolts.

With these extension sensors in a robust and easy-assemble aluminium housing, the same performance features are achieved as when applying strain gauges (DMS) directly. These features include a high resolution, very low drift effects and the options for both static and dynamic measurement.

The extension sensor includes a completely wired DMS that is pressed onto the component to be bonded by a specially formed pressing mechanism when screwing on the extension sensor. Thus the housing serves as a mounting frame for the DMS application.

The surface of the component must be sanded down and cleaned in the strain gauge area before screwing on the extension sensor. The DMS is protected permanently against moisture through a special oil-resistant seal.

The zero adjustment of the strain gauge is performed after assembling the extension sensor of the GSV-2 DMS measuring amplifier. Strains from 0,1µm/m can be displayed.

This corresponds to a mechanical tension of approx. 0,02N/mm² on the surface of a steel component. With the combination of extension sensor and GSV-2 measuring amplifier, switching thresholds from approx. 1µm/m (corresponds to 0,2N/mm²) can be monitored if a zero adjustment is performed periodically.

For applications in weighing technology, an extension range of at least 30µm/m (6 N/mm²) is recommended to achieve the lowest possible drift effects.

Dimensions

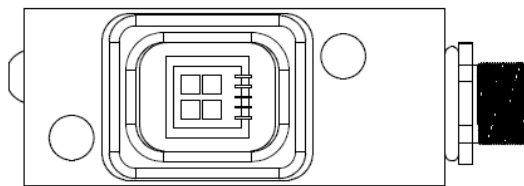
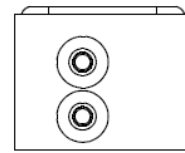
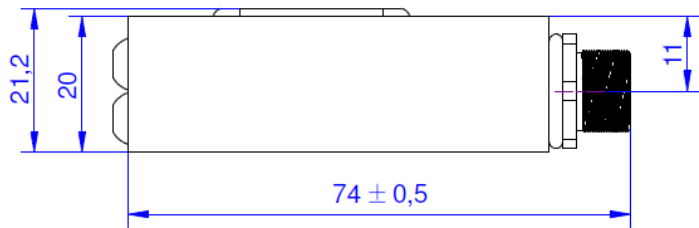
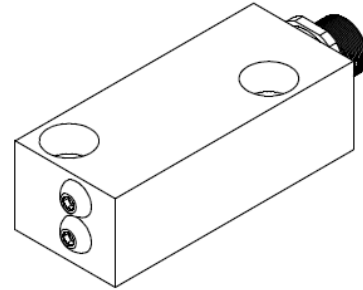
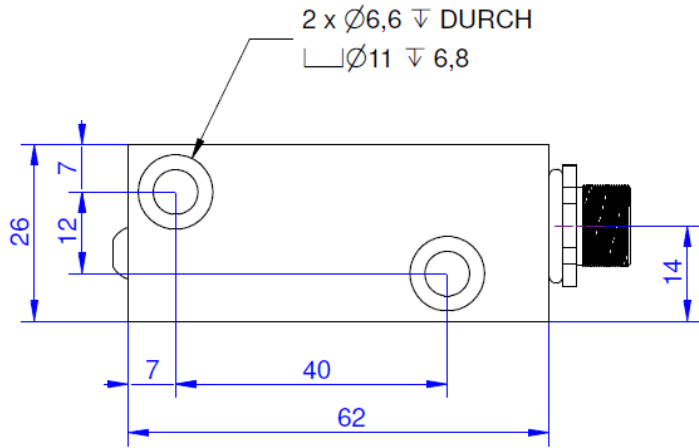

Anschaubfläche

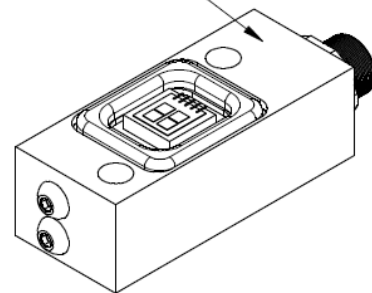

Technical Data

Electrical Data

Input resistance	350 Ohm
Tolerance input resistance	7 Ohm
Output resistance	350 Ohm
Tolerance output resistance	7 Ohm
Insulation resistance	5 GOhm
Rated range of excitation voltage f	2.5 ... 5 V
Operating range of excitation voltage f	1 ... 10 V
Zero signal to	-2 mV/V
Zero signal from	2 mV/V
Rated output	1.3 mV/V

Precision

Temperature effect on zero signal	0.005 mV/V/10K
Temperature effect on characteristic value	1 %v.S./10K

Connection Data

Connection type	Connector
Name of the connection	M12

Temperature

Rated temperature range f	-10 ... 65 °C
Operating temperature range f	-20 ... 85 °C
Storage temperature range f	-20 ... 85 °C
Environmental protection	IP65

Basis Data

Type	Dehnungsaufnehmer
Nominal strain	1000 µm/m
Operating strain	150 %
Fastening	schrauben (M6)
Material	Aluminium alloy

Strain gauge is used with k-factor = 2.

Pin Configuration

Symbol	Description	Wire colour	PIN
+Us	positive bridge supply	brown	1
-Us	negative bridge supply	white	2
+Ud	positive bridge output	blue	3
-Ud	negative bridge output	black	4

Compressive load: positive output signal.



Mounting

With compressive strain in the longitudinal axis, a negative output signal results.

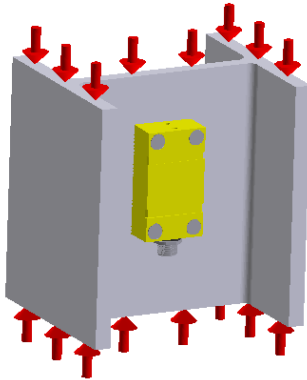
The strain sensor may also be mounted transversely to the direction of the load. In this case, a positive output signal is obtained under compression. By exchanging the lines + Ud and -Ud the sign of the output signal of the strain sensor can be inverted.



accessories

Description	Description
 M-Bond-31	gelatinous, 2-component adhesive in 50 ml double cartridge, 50ml Methacrylate, 50ml Hardener; Operating temperature -55 ° C ... 120 ° C
 Mixing-tool Pack10	Mixing nozzles for double cartridge 50g M-Bond-30 and M-Bond-31; package of 10;
 WS-14	Dispensing gun for 37ml and 50ml double cartridges.